

PART NO.-

C073 Line drawing

TITLE-

Precision Secondary CO2 Regulator

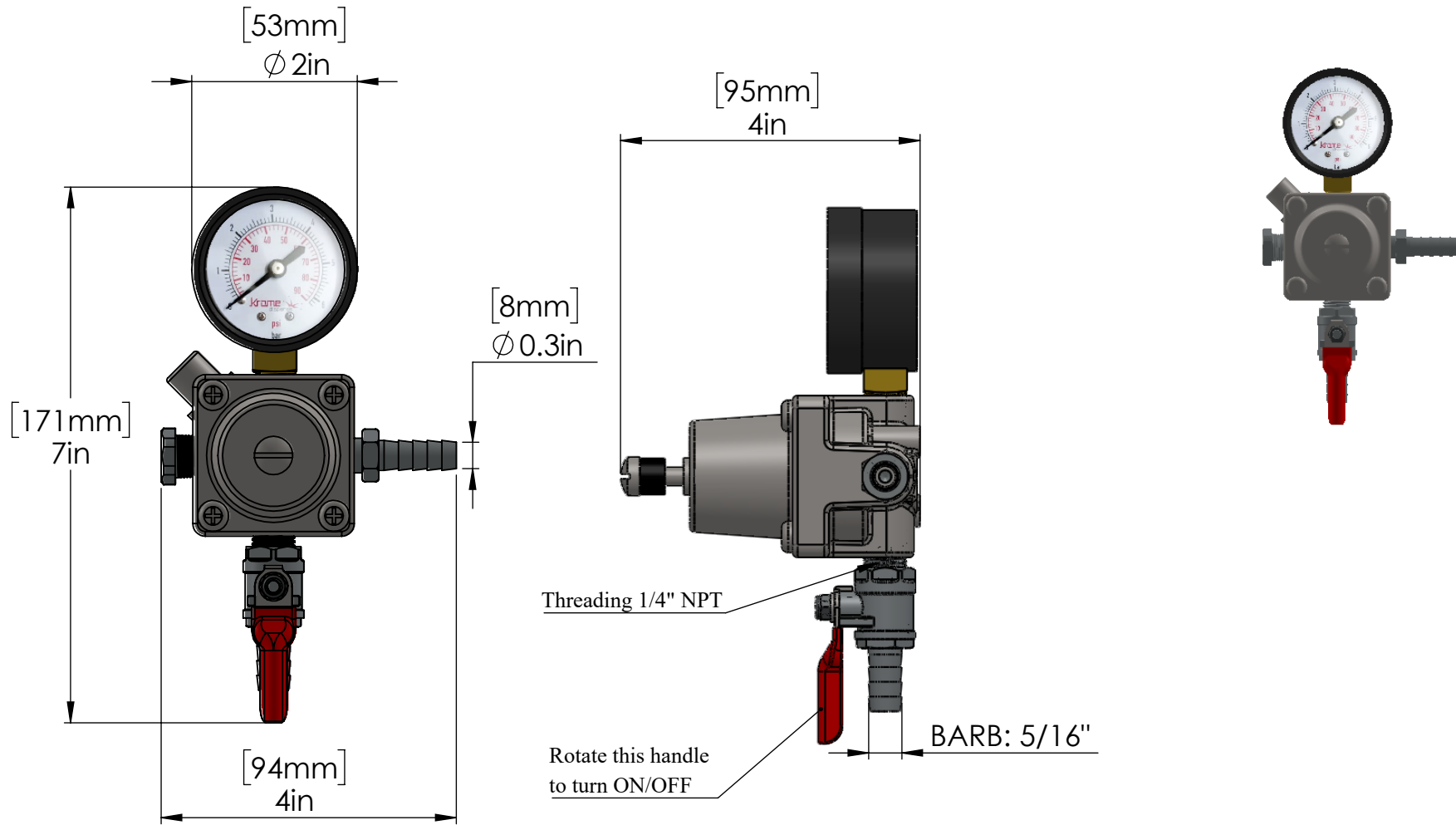

All dimensions are in inches, mm (in bracket)



Note:- Information provided for reference only.

* This document and the information thereon is the property of Krome Dispense Pvt Ltd. & its subsidiaries. Any reproduction in part or as a whole without the written permission of Krome Dispense Pvt Ltd. is prohibited.