

- Made of High Quality Stainless Steel for Durability & Reliability
- 100% Stainless Steel Contact with Beer to Serve Better Tasting
- Modern Look with Brushed Stainless
- Take your pouring to bold new heights

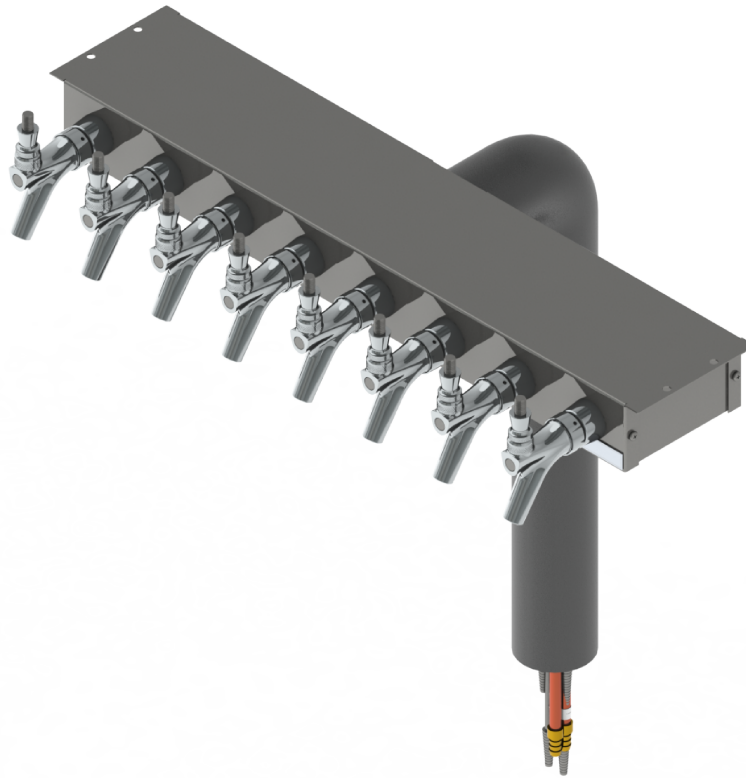

C1240

Brushed Stainless

Specifications:-

Part No	Faucets	Finish	Cooling System
C1240	8	Brushed Stainless	Glyco Cold Technology
C1237	4	Brushed Stainless	Glyco Cold Technology
C1238	5	Brushed Stainless	Glyco Cold Technology
C1239	6	Brushed Stainless	Glyco Cold Technology

Product Dimensions:-

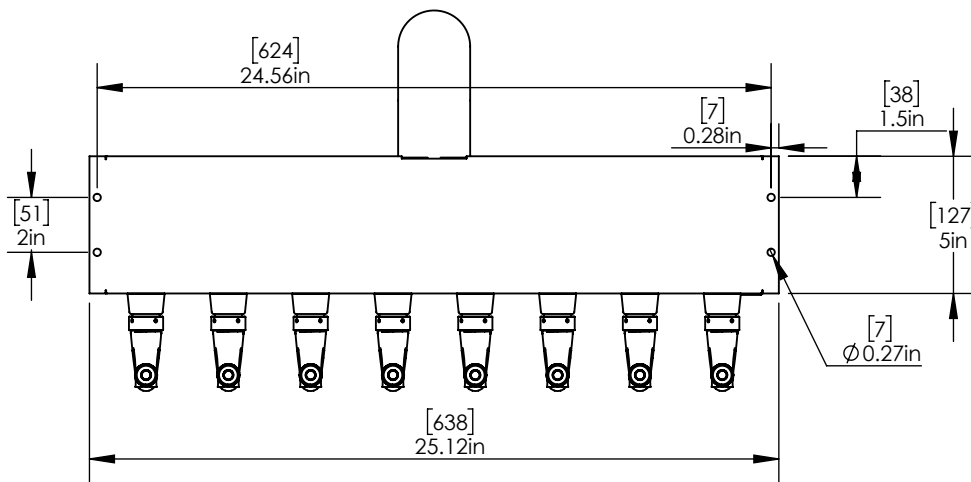

Top View

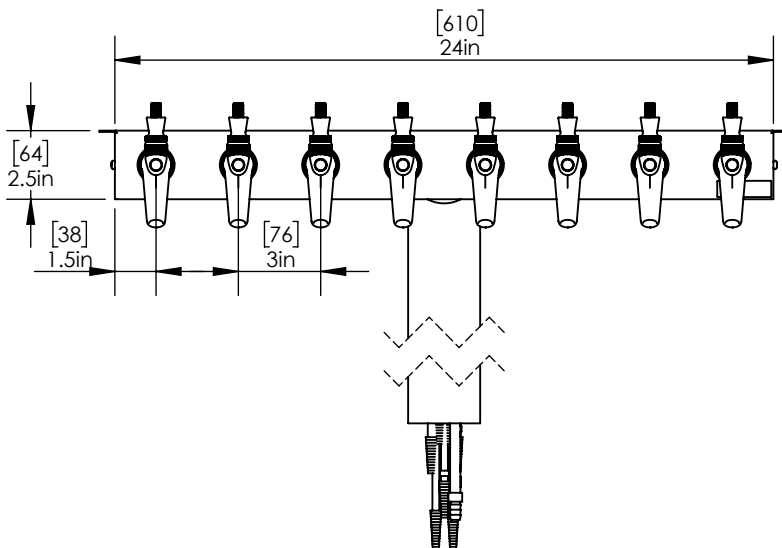

Front View

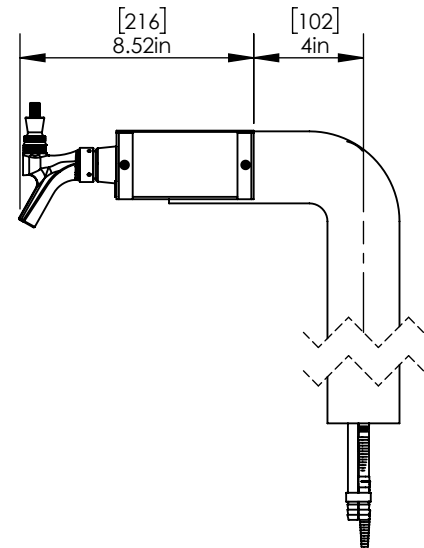

Side View