

- Flat Bottom 50mm Coffee Tamper Base
- Durable Handle Manufactured from Coated Aluminum
- Perfect for the busy espresso bar
- Comfortable Handle Provides Additional Grip



C2283

Brushed Stainless



Options Available

Part Number	Size	Type
C2450	50 mm	Krometamp

Product Dimensions:-

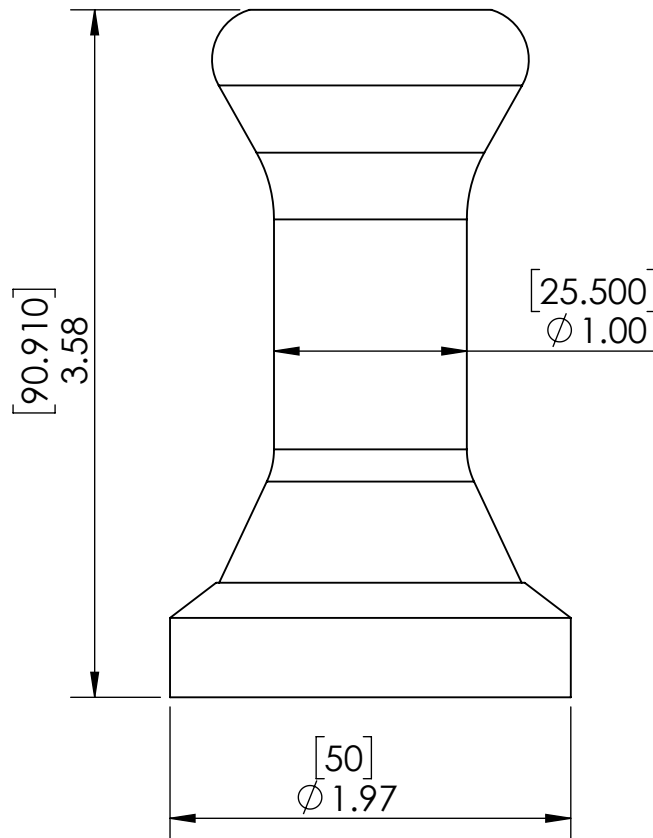

Revision # 1 - -

Copyright © 2017 Krome Dispense. All Rights Reserved

US & Canada :- +1-678 666 2001

Asia:- +91-9814203010

Krome Dispense reserves the right to make revisions to product specifications without any notice
For most updated specification sheet , go to www.kromedispense.com

